

Article number: 03446040

Description: Fluro Heavy Duty Spherical Plain Bearing GE 40 GW-2RS
Hole Ø40

Note: 40

Measures

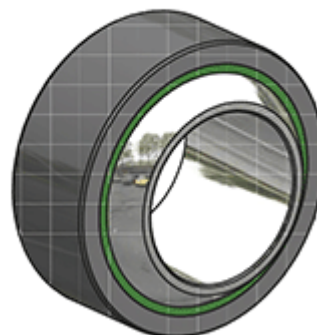
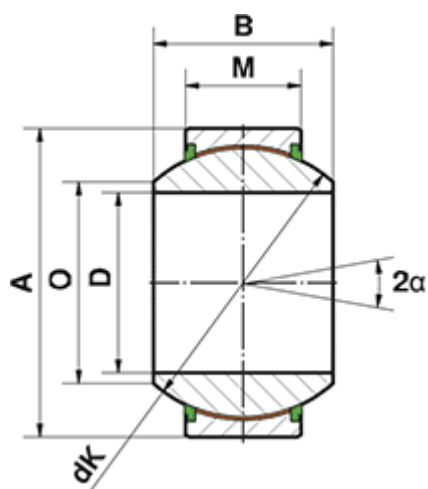

	= -	Dynamic load C (kN) = 360
	= -	M = 25
	= -	O = 44.7
A	= 68	Static load C0 (kN) = 600
a (degrees)	= 17	Weight (g) = 530
B	= 40	
D	= 40	
dK	= 60	